

A close-up photograph of an open electrical enclosure. The enclosure is light-colored, possibly white or light grey, and is shown from a low angle. The interior is dark, and a blue component, likely a terminal block or a similar electrical part, is visible. The background is a bright blue with a bokeh effect, suggesting a light source. The overall composition is clean and professional.

RETTBOX[®]

USER GUIDE

CONTENT

RETTBOX® GENERAL DESCRIPTION	P. 3
INSTALLATION STEPS & DIMENSIONS	P. 5
CONNECTING DIAGRAM RETTBOX®	P. 5
WIRING DIAGRAM/RETTBOX® 20 A.....	P. 6
WIRING DIAGRAM/RETTBOX®-AIR 20 A	P. 7
WIRING DIAGRAM/RETTBOX® 32 A.....	P. 8
WIRING DIAGRAM/RETTBOX®-AIR 32 A	P. 9
OPTIONS	P.10
SPARE PARTS RETTBOX® 20 A	P. 12
SPARE PARTS RETTBOX®-AIR 20 A	P. 13
SPARE PARTS RETTBOX® 32 A & RETTBOX®-AIR 32 A	P. 14



RETTBOX®



ELECTROMAGNETIC SELF-EJECT DECONTACTOR™



20 A/32 A

- ▶ For all types of emergency vehicles
- ▶ DECONTACTOR™ for power supply with secure/ automatic ejection RETTBOX® or power supply with compressed air RETTBOX®-Air
- ▶ AISI 316 L stainless steel housing with electromagnetic coil (12 V DC-24 V DC)
- ▶ Automatic ejection of the coupler socket upon start-up of the vehicle
- ▶ 5 pin connector for Anti-start function
- ▶ Voltage presence indicator
- ▶ RETTBOX®-Air : Compressed air supply up to 13 bar
- ▶ More than 10,000 matings tested (20 A)

MAIN FEATURES

	RETTBOX® (20 A)	RETTBOX®-Air (20 A)	RETTBOX® (32 A)	RETTBOX®-Air (32 A)
Front	stainless steel	stainless steel	stainless steel	stainless steel
Box	glassfiber reinforced polyamide	glassfiber reinforced polyamide	stainless steel	stainless steel
Protection mode (closed cover)	IP55	IP55	IP55	IP55
Self-closing coupler socket	IP55	IP55	IP55	IP55
Front dimensions (LxH) in mm	114 x 184	114 x 184	132 x 188	132 x 188
Cut-out dimensions on vehicle's frame (LxHxP) in mm	83 x 163 x 94	83 x 163 x 94	103 x 173 x 145	103 x 173 x 145
Coupler socket cable supplied	4 m	4 m*	4 m	4 m*
Auxiliary contacts (optional)	2 aux	1 aux	3 aux	3 aux
Weight (excluding coupler socket)	1200 g	1200 g	3200 g	3200 g
Built-in DECONTACTOR™	20 A	20 A	32 A	32 A </td
Compressed air duct	no	up to 13 bars	no	up to 13 bars

* with duct for compressed air

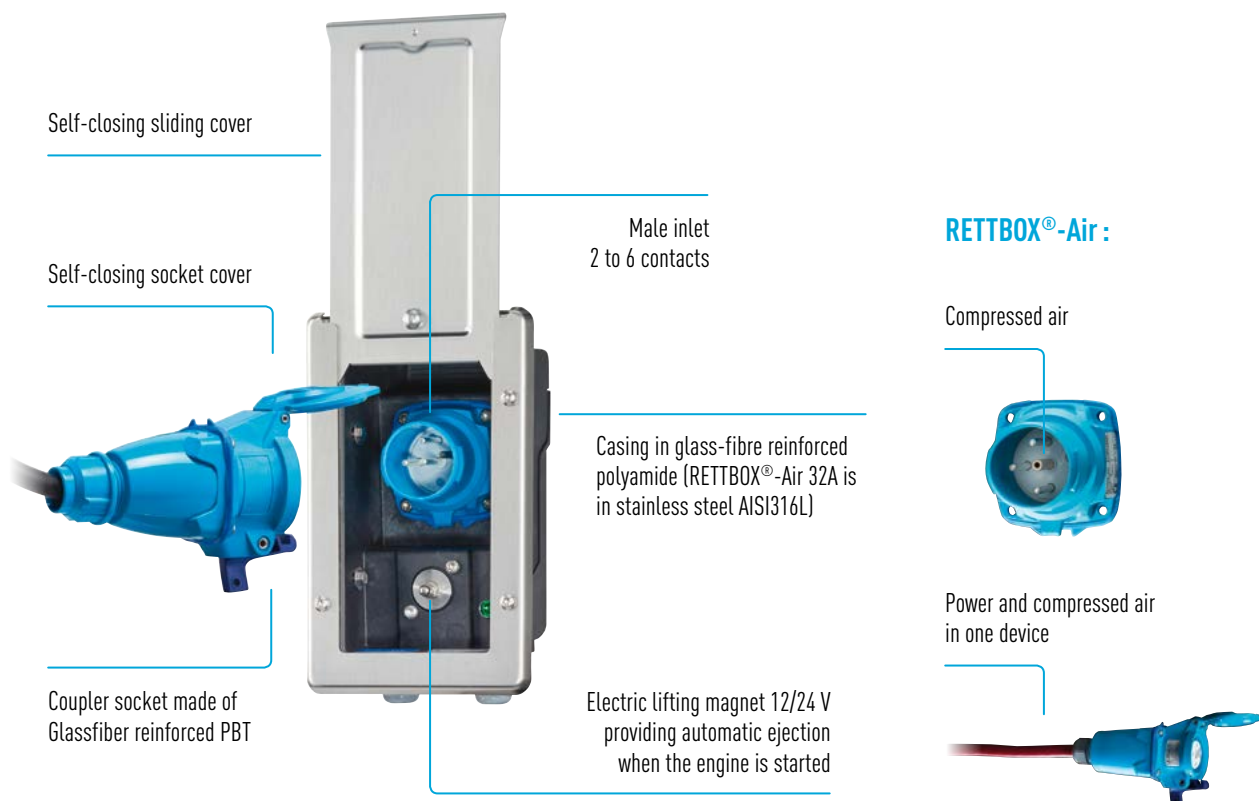

ENSURE SPEED AND SAFETY

- 1 Loading box connected to the electrical system of the vehicle.
- 2 Automatic ejection of the coupler socket upon start-up of the vehicle by way of an electric lifting magnet.
- 3 Protection against water and dust by means of a self-closing cover.

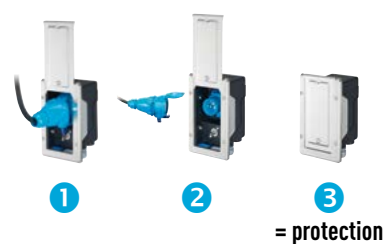
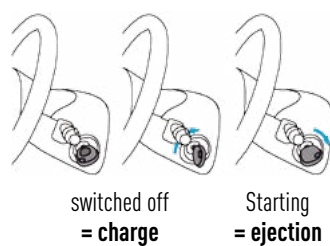

INFOS +

INSTALLATION STEPS & DIMENSIONS

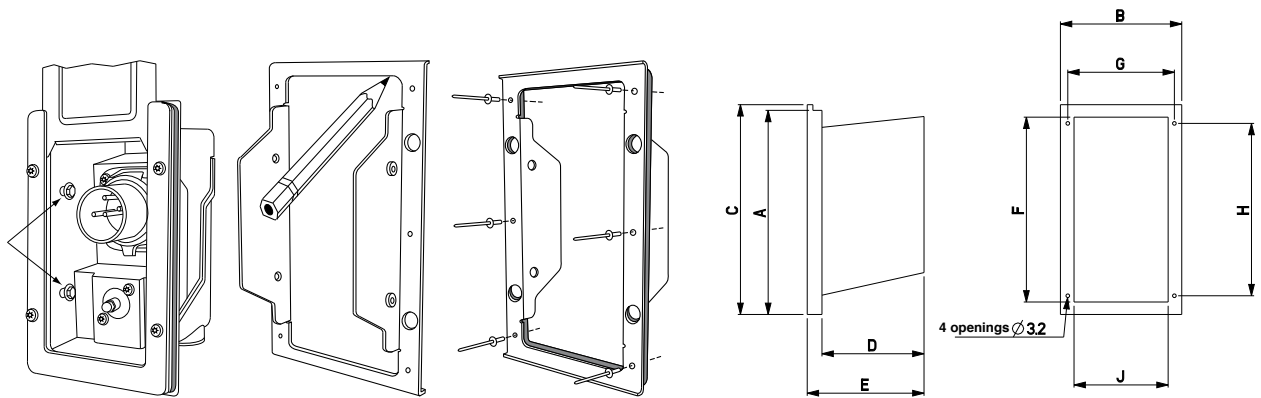

	A	B	C	D	E	F	G	H	J
RETTBOX® 20 A	184	114	184	89	114	163	94	152	83
RETTBOX®-Air 20 A	184	114	184	89	114	163	94	152	83
RETTBOX® 32 A	188	132	197	140	151	173	116	169	103
RETTBOX®-Air 32 A	188	132	197	140	151	173	116	169	103

TYPICAL CONNECTING DIAGRAM RETTBOX®

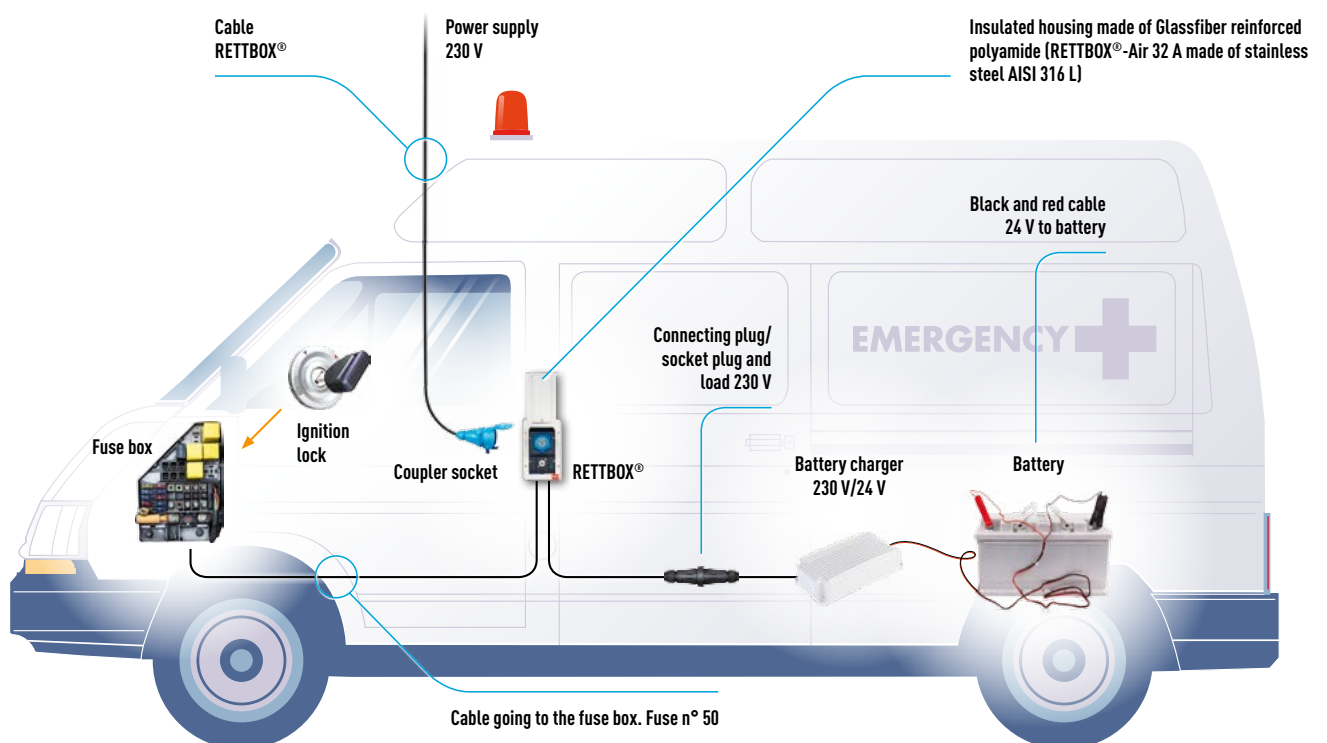



WIRING DIAGRAM/RETTBOX® 20 A



230 V

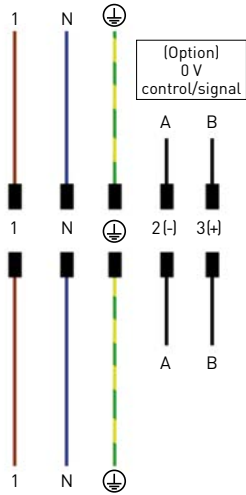

12/24 V

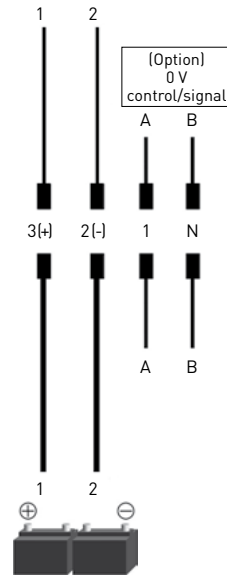

RETTBOX® 20 A/230 V

RETTBOX® 20 A 12/24 V

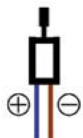

• Observe polarity

2 x 1,5 mm² min.



Due to a standardization, it was necessary to determine the color coding of the electric ejection (magnet) as follows:

BLUE = PLUS (+), BROWN = MINUS (-).

Please be sure to observe the polarity, so that the freewheeling diode will not be damaged.



WIRING DIAGRAM / RETTBOX®-AIR 20 A



230 V

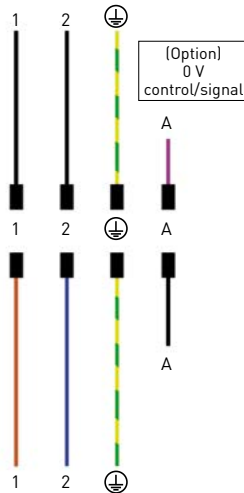

RETTBOX®-AIR 20 A / 230 V

12/24 V

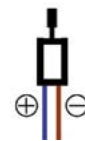
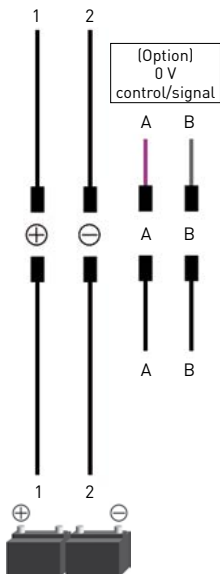

• Observe polarity

2 x 1,5 mm² min.



Due to a standardization, it was necessary to determine the color coding of the electric ejection (magnet) as follows:

BLUE = PLUS (+), BROWN = MINUS (-).

Please be sure to observe the polarity, so that the freewheeling diode will not be damaged.

RETTBOX®-AIR 20 A / 24 V



WIRING DIAGRAM/RETTBOX® 32 A

400 V

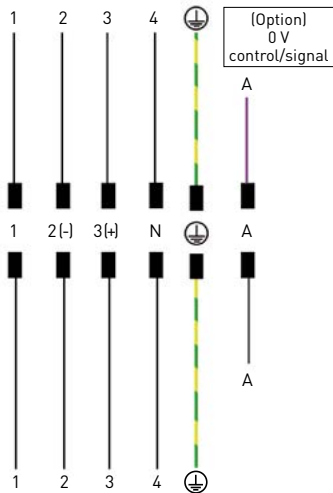

RETTBOX® 32 A/400 V

230 V

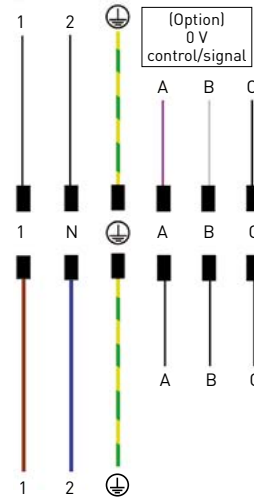

RETTBOX® 32 A/230 V

24 V

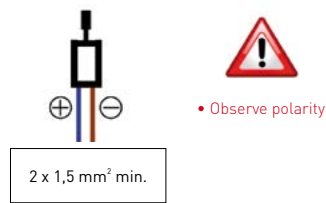
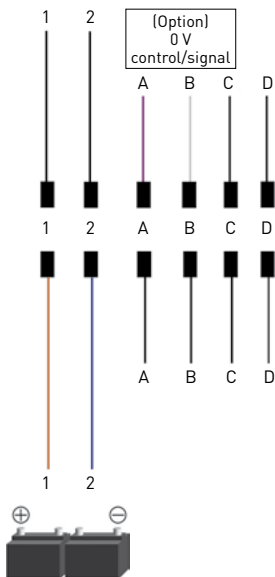

RETTBOX® 32 A/24 V



Due to a standardization, it was necessary to determine the color coding of the electric ejection (magnet) as follows:

BLUE = PLUS (+), BROWN = MINUS (-).

Please be sure to observe the polarity, so that the freewheeling diode will not be damaged.



WIRING DIAGRAM/RETTBOX®-AIR 32 A



400 V

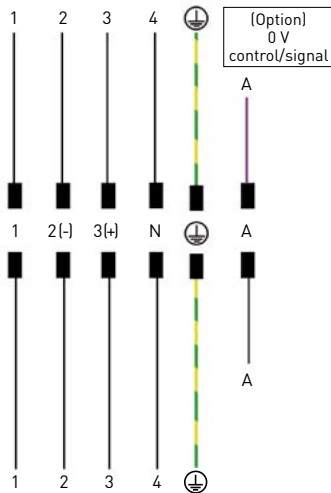

230 V

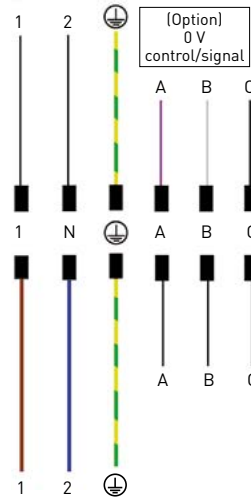

RETTBOX®-AIR 32 A/400 V



RETTBOX®-AIR 32 A/230 V

24 V

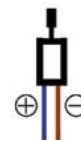
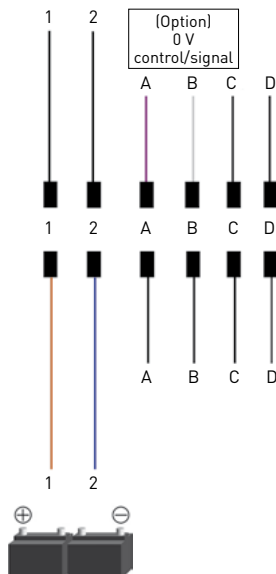

• Observe polarity

2 x 1,5 mm² min.



RETTBOX®-AIR 32 A/24 V



Due to a standardization, it was necessary to determine the color coding of the electric ejection (magnet) as follows:

BLUE = PLUS (+), BROWN = MINUS (-).

Please be sure to observe the polarity, so that the freewheeling diode will not be damaged.



OPTIONS

CEILING SUSPENSION SYSTEM PART NUMBER



(M20) RETTBOX® 20A	611AHUTRRRL
(M25) RETTBOX®-Air 20A	611AHUTAAAL
(M25) RETTBOX® 32A	381AHUTRRRL
(M32) RETTBOX®-Air 32A	381AHUTAAAL

OPTIONAL MOUNTING BOX



RETTBOX®/RETTBOX®-Air	611AAUFBAUA1H
-----------------------	---------------

CONNECTING KIT FOR COUPLER SOCKET



RETTBOX®-Air	611AABZ
--------------	---------

EXTENSION CORD



Extension cord RETTBOX® 2m CEE 230V ...Other on request	6113015RK2041
--	---------------

RETTBOX®-AIR CLOSED



	611AZUU
--	---------

SLIDING DOOR COLORED



Fire red RAL3000, other on request	661ATUER
---------------------------------------	----------





SPARE PARTS RETTBOX® 20 A



RETTBOX® 20 A, INLET



	PART NUMBER
230 V 20 A 1Ph+N+E	6118015RRR
12 V DC 20 A + / -	6118059RRR
24 V DC 20 A + / -	6118089RRR
400 V 20 A 3Ph+N+E	6118017RRR
230 V 20 A 1Ph+N+E+2 aux	6118175RRR

MAGNET FOR RETTBOX® 20 A



12 V	611AMAGRRR12
24 V	611AMAGRRR24

PLUG CONTACT



611A011

SOCKET COUPLER RETTBOX® 20 A WITHOUT CABLE



230 V 20 A 1Ph+N+E	6113015RRR
12 V DC 20 A + / -	6113059RRR
24 V DC 20 A + / -	6113089RRR
400 V 20 A 3Ph+N+E	6113017RRR
230 V 20 A 1Ph+N+E+2 aux	6113175RRR

SOCKET RETTBOX® 20 A



230 V 20 A 1Ph+N+E	6114015RRR
12 V DC 20 A + / -	6114059RRR
24 V DC 20 A + / -	6114089RRR
400 V 20 A 3Ph+N+E	6114017RRR
230 V 20 A 1Ph+N+E+2 aux	6114175RRR

HANDLE FOR RETTBOX® 20 A SOCKET COUPLER



Poly	511POD18
------	----------

CORD FOR MANUAL SEPARATION (SOCKET COUPLER)



611AZIE

SOCKET CONTACT



611A021



SPARE PARTS RETTBOX®-AIR 20 A















RETTBOX®-AIR 20 A, INLET		PART NUMBER
	230 V 20 A 1Ph+N+E access from below	6118015AAAU
	230 V 20 A 1Ph+N+E access from behind	6118015AAAH
	12 V DC 20 A + / - access from below	6118059AAAU
	12 V DC 20 A + / - access from behind	6118059AAAH
	24 V DC 20 A + / - access from below	6118089AAAU
	24 V DC 20 A + / - access from behind	6118089AAAH
MAGNET FOR RETTBOX®-AIR 20 A		
	12 V	611AMAGRRR12
	24 V	611AMAGRRR24
COMPRESSED AIR STICK FOR RETTBOX®-AIR 20 A INLET		
		611ASTI
STRAIGHT COMPRESSED AIR COUPLER FOR RETTBOX®-AIR 20 A INLET		
	Straight	611AGER
ANGLE COMPRESSED AIR COUPLER FOR RETTBOX®-AIR 20 A INLET		
	Angle	611AWIN
PLUG CONTACT RETTBOX®-AIR 20 A		
		611A011
COUPLER SOCKET RETTBOX®-AIR 20 A, WITHOUT CABLE		
	230 V 20 A 1Ph+N+E	6113015AAA
	12 V DC 20 A + / -	6113059AAA
	24 V DC 20 A + / -	6113089AAA
SOCKET RETTBOX®-AIR 20 A		
	230 V 20 A 1Ph+N+E	6114015AAA
	12 V DC 20 A + / -	6114059AAA
	24 V DC 20 A + / -	6114089AAA
HANDLE FOR COUPLER SOCKET RETTBOX®-AIR 20 A		
	Poly	511P025P
CORD FOR MANUAL SEPARATION (SOCKET COUPLER)		
		611AZIE
COMPRESSED AIR COUPLER FOR RETTBOX®-AIR 20 A SOCKET		
		611ADRU
SOCKET CONTACT		
		611A021



SPARE PARTS RETTBOX® 32 A & RETTBOX®-AIR 32 A



RETTBOX®-AIR 32 A, INLET		PART NUMBER
	230 V 32 A 1Ph+N+E+3aux	3818187AAA
	400 V 32 A 3Ph+N+E+1aux	3818247AAA
MAGNET FOR RETTBOX®-AIR 32 A		
	12 V	381AMAGAAA12
	24 V	381AMAGAAA24
COMPRESSED AIR STICK FOR RETTBOX®-AIR 32 A INLET		381ASTI
		
STRAIGHT COMPRESSED AIR COUPLER FOR RETTBOX®-AIR 32 A INLET		
	Straight	381AGER
PLUG CONTACT RETTBOX®-AIR 32 A		311A011
		
PLUG AUXILIARY CONTACT RETTBOX®-AIR 32 A		311A011972
		
COUPLER SOCKET RETTBOX®-AIR 32 A, WITHOUT CABLE		
	230 V 32 A 1Ph+N+E+3aux	3813187AAA
	400 V 32 A 3Ph+N+E+1aux	3813247AAA
SOCKET RETTBOX®-AIR 32 A		
	230 V 32 A 1Ph+N+E+3aux	3814187AAA
	400 V 32 A 3Ph+N+E+1aux	3814247AAA
HANDLE FOR COUPLER SOCKET RETTBOX®-AIR 32 A		512P032P
	Poly	
CORD FOR MANUAL SEPARATION (SOCKET COUPLER)		611AZIE
		
COMPRESSED AIR COUPLER FOR RETTBOX®-AIR 32 A SOCKET		381ADRU
		
SOCKET CONTACT RETTBOX®-AIR 32 A (SAME ONE FOR AUXILIARIES)		311A021
		



WEBSITE

- Retrieve your business contacts.
- Download our documentation related to your field of activity.
- Learn more about our group.
- Discover our new products.
- Follow our current events.
- Ask your questions online.

FIND ALL INFORMATION
ON OUR WEBSITE:



marechal.com

NON CONTRACTUAL DOCUMENT AND PICTURES

All the indications appearing in this catalogue are indicative and could not constitute a commitment on our part. We reserve the right to alter specifications of our products without any prior notice in our efforts to continuously improve our products features.

For your information, the most updated version is the one of our website marechal.com.



WORLD PRESENCE

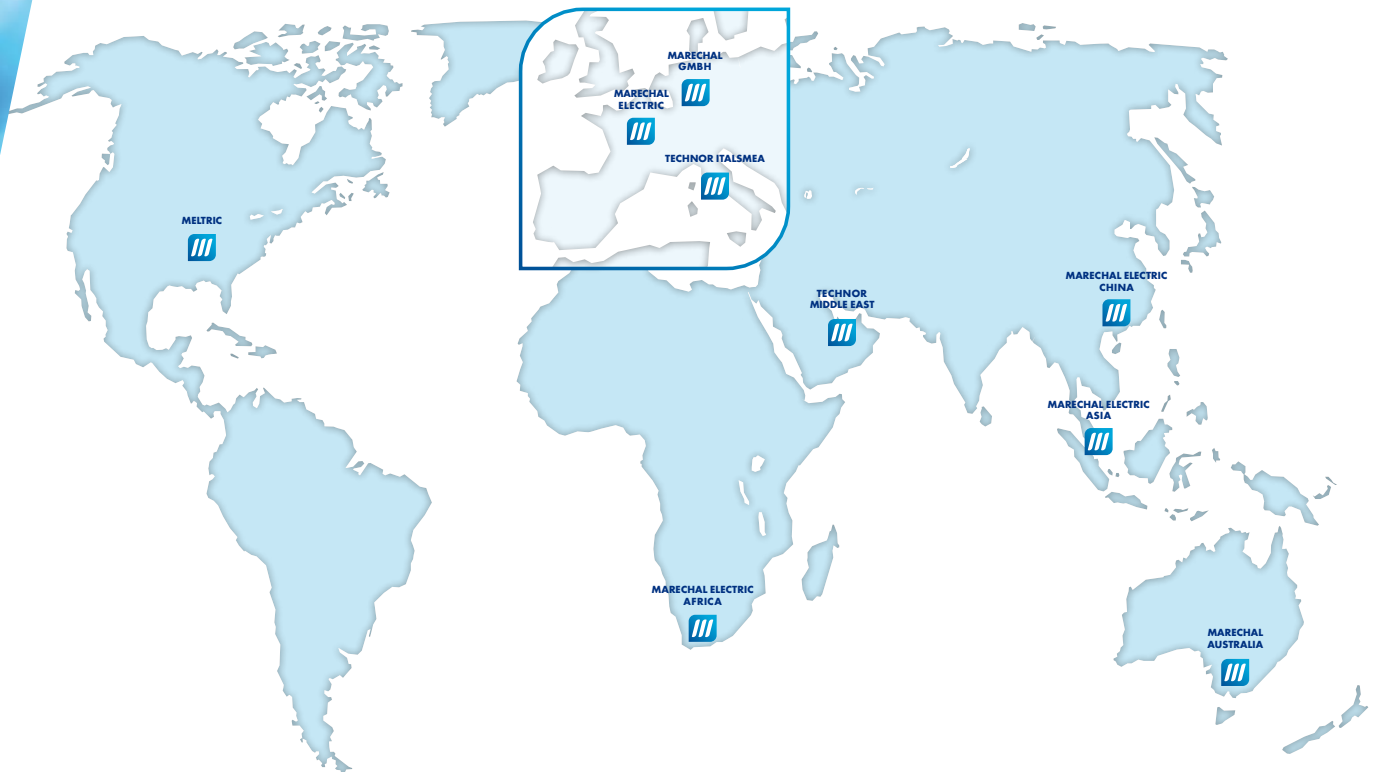

MARECHAL ELECTRIC S.A.S (Head Office)

5, avenue de Presles
94417 Saint-Maurice Cedex, FRANCE
Phone : +33 (0)1 45 11 60 00
Fax : +33 (0)1 45 11 60 60
e-mail: contact@marechal.com

Africa SADC area

MARECHAL ELECTRIC AFRICA (PTY) LTD.
PO Box 13875 Witfield 1467
Unit A1 Harvard Lane
Aero Star Business Park
Jet Park Road, Jet Park
South Africa
Tel.: +27 11 894 7226/7/8
Fax: 086 604 1778
e-mail: sales.za@marechal.com

Asia

MARECHAL ELECTRIC Asia Pte Ltd
#01-05 9@Tagore
9 Tagore Lane
Singapore 787472
Tel.: +65 6554 2722
Fax: +65 6455 9077
e-mail: sales.asia@marechal.com

Australia

MARECHAL AUSTRALIA PTY LTD
20 Technology Circuit
HALLAM VIC 3803
Australia
Tél. : +61 (0)38786 2500
Fax : +61 (0)38786 2511
e-mail : sales@marechal.com.au

China

MARECHAL ELECTRIC (CHINA) Co., Ltd
11 North Xiangshui Road,
West Dayawan District,
Huizhou.P.R.C
Tel/Fax: +86 (0)752-5319536
e-mail: sales.cn@marechal.com

Germany/Austria/Switzerland/ East Europe/Russia

MARECHAL GmbH
Im Lossenfeld 8
D-77731 Willstätt-Sand
Germany
Tel.: +49 (0)7852/91 96-0
Fax: +49 (0)7852/91 96-19
e-mail: info.de@marechal.com

Middle East

Technor Middle East DMCC
Unit No.2101, Fortune Executive
Tower, Plot No T1
Jumeirah Lakes Towers
P.O. Box 392054
Dubai, United Arab Emirates
Tel.: +971 4 362 1418
Fax: +971 4 362 1419
e-mail: sales.me@marechal.com

USA/Canada/Mexico

MELTRIC Corporation
4765 W. Oakwood Park Drive
Franklin WI 53132, USA
Tel.: +1 414 433 2700
Fax: +1 414 433 2701
e-mail: mail@meltric.com

TECHNOR

TECHNOR ITALSMEA S.p.A.
Via Italia 33,
20060 Gessate (MILANO)
Italia
Tél. : +39 02 95 00 151
Fax : +39 02 95 00 15 27
e-mail: sales@italsmea.com

For any other country or area, please contact head office.

marechal.com