

HK-L Series Chager Main Parameter

- **Overview**

HK-L series 6.6KW charger is a product specially designed for electric vehicle power battery supplementary electric energy according to the national standard of charger. This product not only has the advantages of high efficiency, small size, high stability, long life, etc., but also has the characteristics of high protection level, high reliability, and complete protection functions. It is an ideal power source for electric vehicle charging. The charger has a built-in thermal induction device with overheat protection function and can automatically recover. The fully sealed potting process and the protection level of up to IP67 can ensure that it can work in any complex environment without causing failure.

Main features:

1. Support UDS diagnosis CAN wake-up function
2. Fully sealed process can work reliably under the conditions of -40°C-+85°C
3. Built-in temperature sensor to shut down output under hazardous operating conditions (internal 90°C)
4. Protection class IP67 Can work safely under short-term water immersion conditions

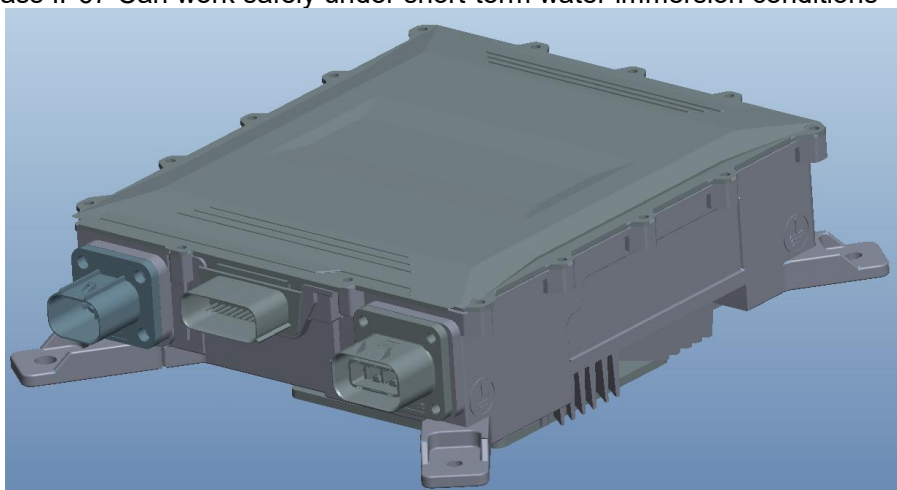

Water -cooling

- **Models**

Models	Cooling method	Voltage Platform	Hardware	Power	Weight (kg)
HK-LF-108-60	Air cooling	108V	177V/60A	6.6KW	
HK-LF-144-46	Air cooling	144V	202V/46A	6.6KW	
HK-LF-312-20	Air cooling	312V	450V/20A	6.6KW	
HK-LF-540-14	Air cooling	540V	680V/14A	6.6KW	

Label Definition :



- Notes: 1. For the product model, see the model definition table
2. The configuration code changes according to customer needs
3. See the following technical specifications for the output range of OBC

1. Main parameter

Voltage Platform		96V/108V	144V	312V	540V
Output	Output voltage range	65~140V	90~195V	250~450V	350~680V
	Output current	60A	46A	20A	14A
	Output power	6600W@220VAC 3300W@110VAC			
	Output Mode	CV / CC			
	CV Accuracy	±1%			
	CC Accuracy	±2%			
	Ripple Voltage Coefficient	5%			
Input	Input voltage range	AC 90~264V			
	Frequency	45-65Hz			
	Input current	32A			
	Power factor	≥0.98 more than half load			
	Effeciciency	≥93% full -load			
	Stand-by Consumption	≤5W			
Low Voltage Output	Output Mode	Constant Voltage			
	Output Voltage	13.8V			
	Rated Current	5A			
	CV Accuracy	±2%			

	Output Power	≥62.5W
	Ripple Voltage Coefficient	1%
Protection function	Input Over-voltage Protection	AC270±5V
	Input Under-voltage Protection	AC85±5V
	Output Over-voltage Protection	Stop the output when exceeds + 2% of the maximum output voltage
	Output Under-voltage Protection	Stop the output when below -5% of the minimum output voltage
	Output Over-current Protection	Stop the output when exceeds + 5% of the maximum output current
	Over-temperature Protection	Power down from 85 °C and turn off at 90°C
	Short-circuit Protection	Stop Output
	Battery Reverse Connect Protection	Yes
	Ground Protection	≤100mΩ
	CAN communication Protection	Automatically stop the output when CAN communication fails
	Power-off Protection	Yes
Signal Port	CC signal detection	100Ω—3.3k-Infinite
	CP signal detection	0%—100%, 5V—15V Vpp
	CC Singal output	220Ω or 680Ω
	Temperature detection	Two inputs, support 1K and 10K
	12V wakeup input	≤10mA
	12V wakeup output	Max 0.2A
	12V constant power	Sleep current≤1mA, peak current≤5A
	Electromagnetic lock drive	Maximum peak current 5A
	Electromagnetic lock in position signal	Switch
	CAN Cmmunication	Yes
	Baud rate	125Kbps、250Kbps、500Kbps
Terminal Resistance	No	
Safety and others	Withstand Voltage	Input to Output: 2500VAC≤10mA Input to Ground: 2000VAC≤10mA Output to Ground: 2000VAC≤10mA, all 1min

		<100MΩ Testing current 25A AC
Insulation Resistance		Input, output, signal terminal to casing≥10MΩ Testing Voltage 1000VDC
Electromagnetic Immunity		GB/T 18487.3-2001 11.3.1
Electromagnetic Abusive		GB/T 18487.3-2001 11.3.2
Harmonic Current		GB 17625.1-2003 6.7.1.1
Inrush Starting Current		≤24A
Current-rise Time		≤5S, Overshoot≤5%
Close Response time		100%-10%≤50mS, 100%- 0%≤200mS
Protection Level		IP67
Vibration Resistance		10 – 25Hz Amplitude1.2mm, 25 – 500Hz 30m/s ² , 8hrs per direction
Noise		≤60dB(Grade A)
MTBF		150000H
Work Environment		Relative Temp 5%-95% No condensation
Working Temperature		-40 ~ 85℃
Storage Temperature		-40℃ ~ +105℃
Over temperature protection		The module stops working when the temperature reaches 90 degrees, and the power supply automatically resumes normal operation after cooling

3. Interface definition diagram

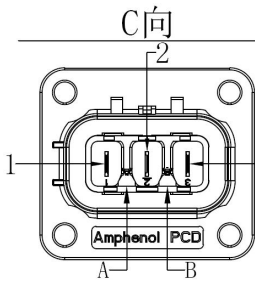
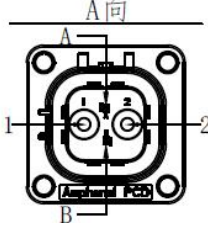
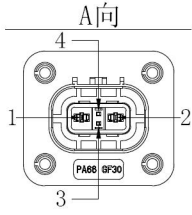
HVSL633023A Charger input							
Volta ge level	Brand	Pin	Terminal Definition	Matching plug-in model	Matching terminal	Parts	Picture
220VA C	Amph enol	1	Naught wire N	HVSL633063 A1	C310003 623	Included	
		2	Earth wire PE				
		3	LiveWire L				
		A、B	High Voltage Interlock HVIL				
HVSL362022A(SP01B022A)							
108V/ 144V	Amph enol	1	Positive	HVSL362062 A110I (SP01B062A1 10I)	C310023 5021 (SP01N4 5001S)	Included	
		2	Negative				
		A.B	High Voltage Interlock HVIL				
DJSL-Z2J(16A) charger output							
Volta ge level	Brand	Pin	Terminal Definition	Matching plug-in model	Matching terminal	Parts	Picture
312V/ 540V	中航 电子	1	Positive	DJSL-T2K(16 A)	Included	Included	
		2	Negative				
		3、4	High Voltage Interlock HVIL				

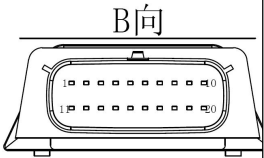
348302001 Signal interface							
Voltage level	Brand	Pin	Terminal Definition	Matching plug-in model	Matching terminal	Parts	Picture
All	Molex	20Pin	See the table below "Signal Interface Definition"	334722006	330122002	the rest (inclusive) 34345001 (blind blocking)	

4. Principle Diagram

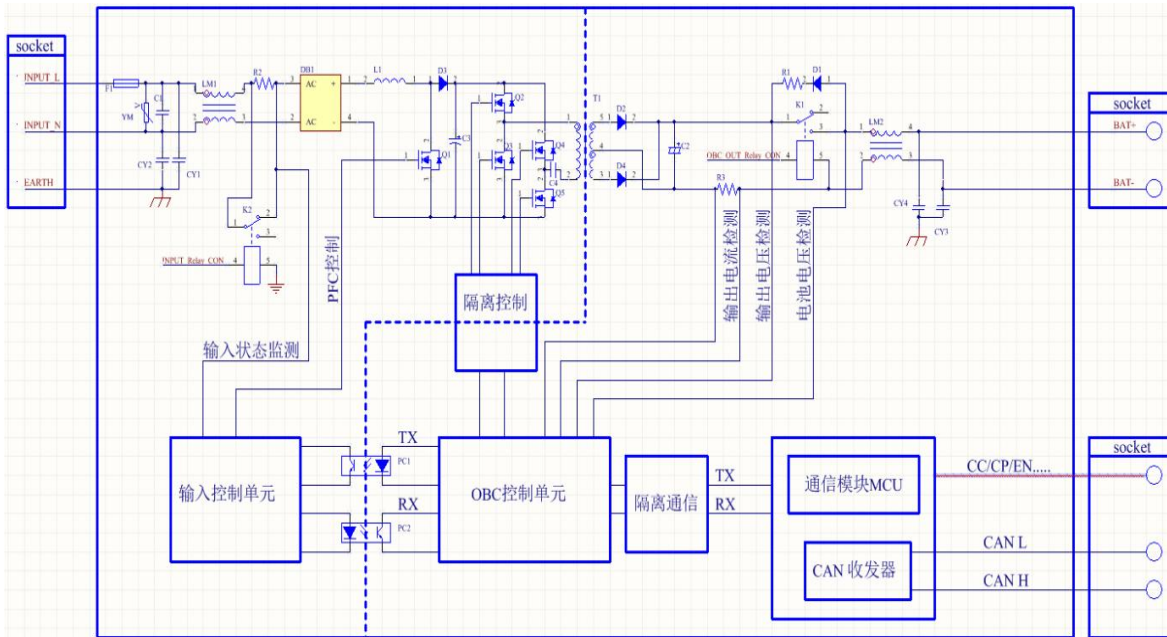

5. Efficiency Curve

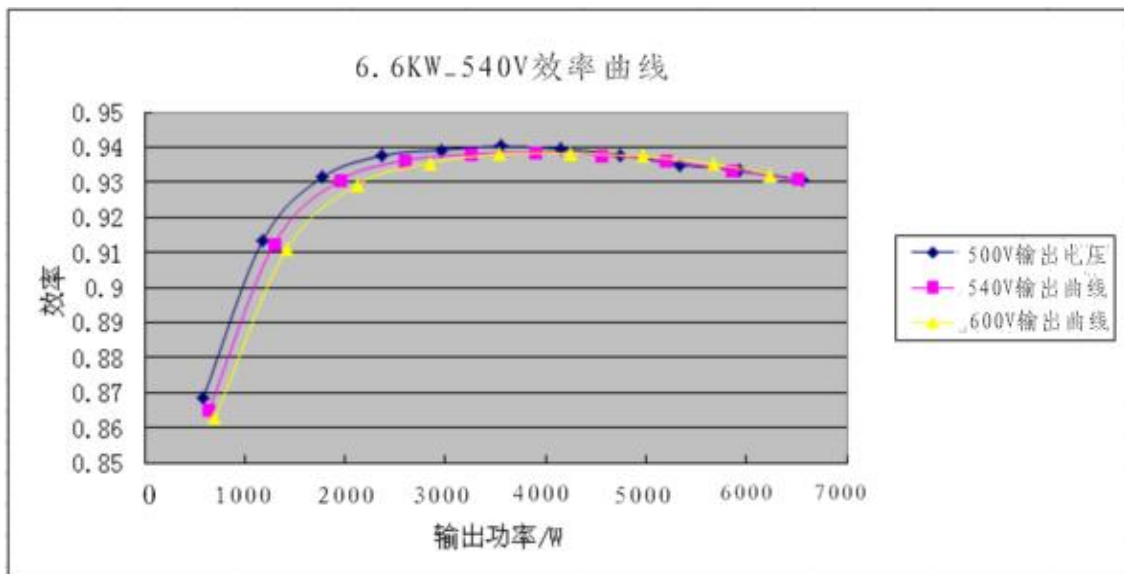
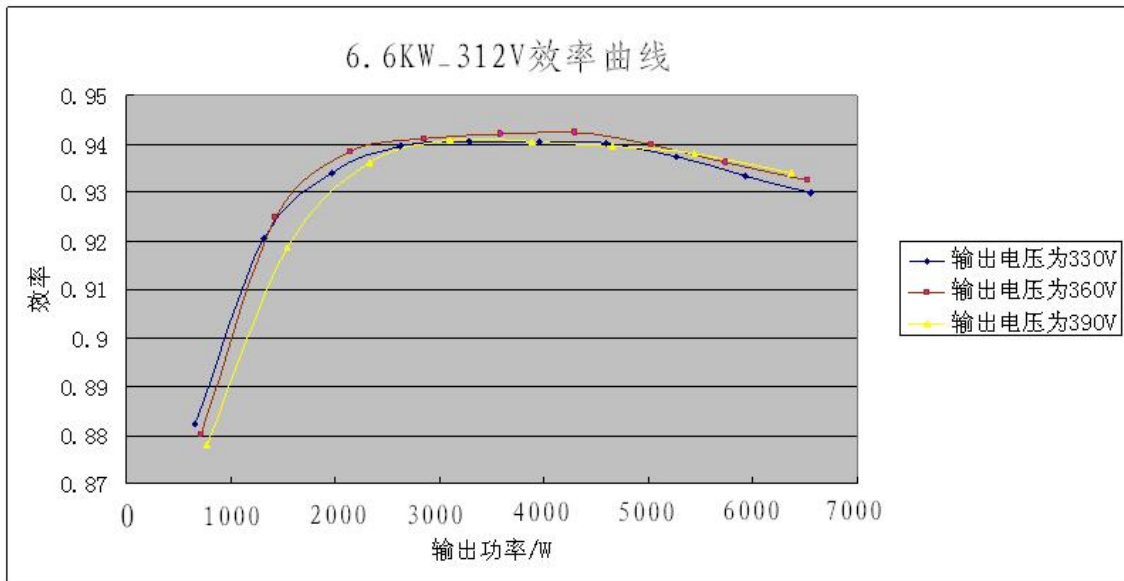
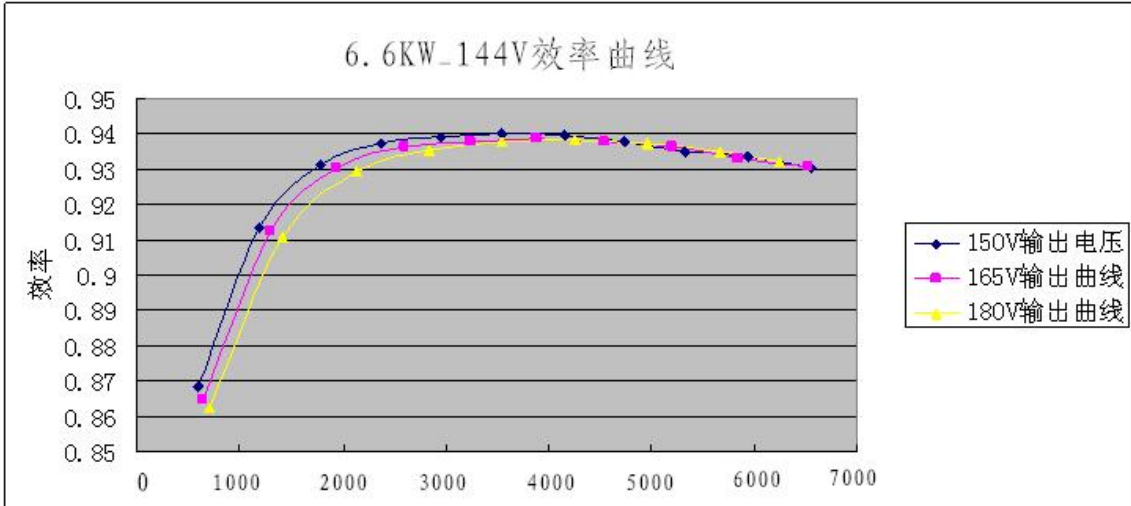

6. Installation Dimensions

Air-cooled installation requirements:

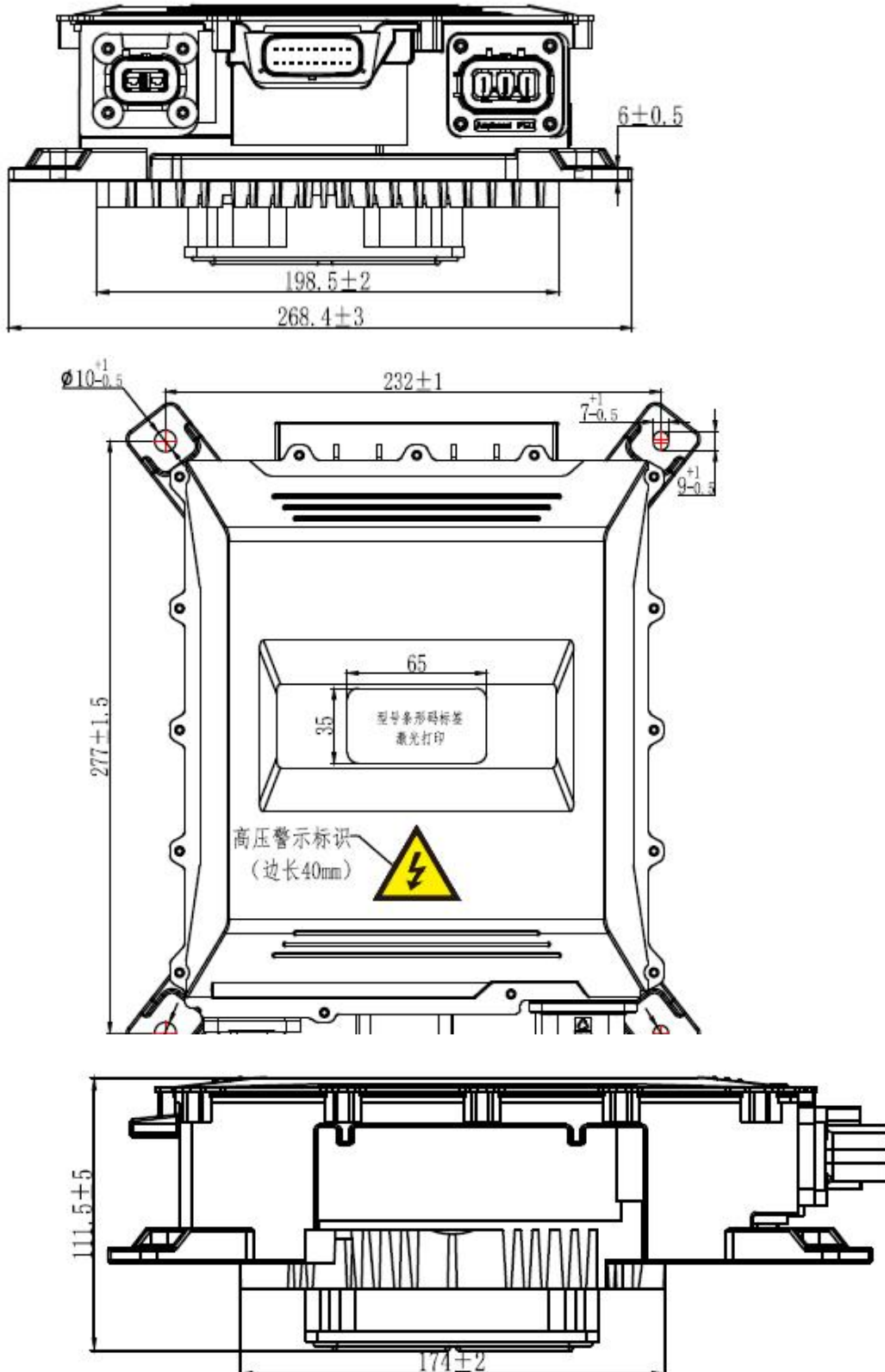

7. **Standard CAN protocol** (can also be customized according to customer requirements)

Can protocol NO.	1000
CAN baud rate	250K

OUT	IN	CAN ID	Cycle (ms)
BMS	Charger	0x1806E5F4	1000
Dats			
Position	Data Name		
BYTE1	Max Allowable Charging Terminal Voltage High Byte		0.1V/bit offset: 0 e.g.: Vset =3201, its corresponding 320.1v。
BYTE2	Max Allowable Charging Terminal Voltage Low Byte		
BYTE3	Max Allowable Charging Current High Byte		0.1A/bit offset: 0 e.g.: Iset =582, its corresponding 58.2A。
BYTE4	Max Allowable Charging Current Low Byte		
BYTE5	Control		0: Start charging. 1: battery protection, stop charging
BYTE6	Reserved		
BYTE7	Reserved		
BYTE8	Reserved		

OUT	IN	CAN ID	Cycle (ms)
CCS	BCA	0x18FF50E5	1000
Data			
Position	Data name		
BYTE1	Max Allowable Charging Terminal Voltage High Byte		0.1V/bit offset: 0 e.g.: Vout =3201, its corresponding 320.1v
BYTE2	Max Allowable Charging Terminal Voltage Low Byte		
BYTE3	Max Allowable Charging Current High Byte		0.1A/bit offset: 0 e.g.: Iout =582, its corresponding 58.2A
BYTE4	Max Allowable Charging Current Low Byte		
BYTE5	STATUS		The highest BIT indicates the symbol, 0: charging 1 : discharging.
BYTE6	Reserved		
BYTE7	Reserved		
BYTE8	Reserved		

STATUS	Mark	Description
Bit0	Hardware Failure	0: Normal. 1: Hardware Failure
Bit1	Temperature of Charger	0: Normal. 1: Over temperature protection
Bit2	Input Voltage	0: Input voltage is normal. 1. Input voltage is wrong, the charger will stop working
Bit3	Starting state	0: Battery is connected normally. 1: Battery is not connected or the battery is connected reversely.
Bit4	Communication State	0: Communication is normal. 1: Communication receive time-out.
Bit5		
Bit6		
Bit7		

Control Mode

1. The BMS sends operating information(Message 1) to charger at fixed interval of 1s. After receiving the message, the charger will work under the Voltage and Current in Message. If the Message is not received within 5s, it will enter into communication error state and stop charging.
2. The charger send broadcast message (Message 2) at intervals of 1s. The display meter can show the status of the charger according to up-to-date information.